

Instruction Manual

Nlx3



Issue

Information on issue	
Document ID	NAN-KD-0020-EN
Issue	V01.06
Date	May 2021

Issued by

© 2021 - NORIS Automation GmbH

Muggenhofer Str. 95

90429 Nuremberg

Germany

Phone: +49 911 3201 0

Fax: +49 911 3201 150

Email: info@noris-group.com

Table of contents

1	General information	5
2	General information	7
2.1	Scope of validity	7
2.2	Notes on declarations of conformity	7
2.3	Subject of the instruction manual	7
2.4	Use of safety and warning notes	7
2.5	Scope of delivery	8
2.6	Accessories and spare parts	8
2.7	Packaging and its disposal	8
3	Product description	10
3.1	Scope of application	10
3.2	Indication principle and measurement signal resolution	10
3.3	Indicator design	11
3.4	Dial and pointer for Type NIQ3, NIR3	12
3.5	Scale and dial for Type NIQ31	13
3.6	Zero point, return point and scale measuring range	13
4	Technical data	16
5	Installation	19
5.1	Information on avoiding faults and damage	19
5.2	Indicator installation	19
5.2.1	Control panel cut-out	19
5.2.2	Securing the indicator	20
5.3	Connection and cable installation	22
5.3.1	Measured variables	22
5.3.2	General connection assignments and connector variants	25
5.3.3	Connection diagrams of the various indicator types	25
6	Commissioning	28
6.1	Tools and equipment	28
6.2	Checking operating voltage and illumination control	28
6.3	Checking the input signal	29
6.4	Referencing	29
6.5	Indicator-specific settings	29
6.5.1	Factory settings	29
6.5.2	Illumination control	30
6.5.3	Linear line compensation for temperature indicator	32
6.5.4	Proportional line compensation	32
6.5.5	Setting direction of rotation for indicators with frequency input and direction of rotation recognition	33
6.5.6	Setting direction of rotation of motor for 360° indicators	34
6.5.7	Zero point calibration for 360° indicators	34

7	Operation	35
7.1	Min/max display.....	35
7.2	Signalling LED and flashing pointer.....	36
7.3	Limit value switch output.....	36
8	Maintenance	37
9	De-installation and disposal	38
10	Troubleshooting	39
11	Service	40

1 General information

Use for intended purpose

- The product may only be used for the applications specified in this document and in the technical documentation. Transportation with due care and attention, correct storage and installation as well as careful use and maintenance during operation of the product must be ensured to guarantee trouble-free and safe operation.
- The product must be used at all times in agreement with the technical specifications. In particular, compliance with the ambient conditions recommended in the technical documentation must be ensured.

Installation, assembly, repair and maintenance work

- Observe the relevant national regulations and observe the applicable standards and directives for special applications.
- Installation, assembly, repair and maintenance work must be carried out exactly according to the installation and maintenance instructions applicable to the individual products in order to guarantee their functional reliability and avoid installation errors and damage.
- Installation, assembly, repair and maintenance work must only be performed by qualified and authorised technical personnel in accordance with the relevant documentation, especially the safety and warning information contained therein.
- Make sure that no excess parts (screws, tools, etc) are left behind in or on products after performing installation, assembly, repair or maintenance work. Non-compliance with this requirement may cause malfunctions and/or damage to the products or the system.
- Make sure a function test is carried out on completion of installation, assembly, repair and maintenance work to ensure trouble-free operation of the products.

Suitable tools and equipment

Only suitable tools and equipment, especially materials provided by NORIS, are to be used for installation, assembly, repair and maintenance work. Damaged products or components are to be replaced only by genuine NORIS components or parts. NORIS shall accept no liability whatsoever for any damage incurred as the result of using unauthorised spare parts. This will invalidate the warranty. Keep the operating instructions in a place that is accessible to all users at any time.

Modification of products

NORIS shall accept no liability whatsoever if unauthorised modifications have been made to the products. This will also invalidate the warranty. Therefore, consult our technical staff before undertaking any modifications.

Shipping, appropriate storage and packaging

Products that are sent in for repair must be appropriately packaged to prevent damage (from impacts, moisture, static charge, etc). Make sure that products and all spare parts are stored correctly. Refer to the corresponding technical information for further information.

Disclaimer

We review the contents of our technical documentation at regular intervals to ensure it agrees with our products. Nevertheless, variations cannot be completely ruled out. NORIS therefore cannot guarantee complete agreement of the documentation contents with the hardware and software. Changes and corrections will be included in subsequent issues of the technical documentation.

2 General information

2.1 Scope of validity

This instruction manual applies the indicator series listed below:

Indicator type	Product revision
NIR3..., NIQ3...	From revision A or higher
NIQ31 (360° indicator with dial)	From revision A or higher

Important information on the use of this instruction manual and supplementary information

Please note that the indicators are adapted to customer-specific requirements. The functions, connections, etc. described in this instruction manual may vary in terms of the features on your specific product. Therefore, always first refer to the information in the customer-specific drawing for installation, commissioning and operation.

2.2 Notes on declarations of conformity

Declarations of conformity for our products are available as download on our website. You can find the declarations of conformity on the related product website in the register tab "Downloads".

2.3 Subject of the instruction manual

The subject of this instruction manual is the installation, commissioning, operation and maintenance of the indicators type NIR3..., NIQ3... . This instruction manual also contains important troubleshooting information.

2.4 Use of safety and warning notes



Warning about the type and source of immediate danger that leads to death or serious injuries when disregarding the given precautions.



Warning about the type and source of danger that may possibly lead to death or serious injuries when disregarding the given precautions.

**CAUTION**

Warning about the type and source of danger that may lead to minor injuries when disregarding the given precautions.

NOTICE

Warning about the type and source of danger that may lead to material damages when disregarding the given precautions.

2.5 Scope of delivery

Note on customer-specific scope of delivery

The scope of delivery of your product may vary from the specifications below. Refer to the corresponding parts list for a detailed overview of the scope of delivery for your product.

The standard scope of delivery contains:

- Indicator packed in a polyethylene bag.
- 4 fastening screws per analogue indicator for mounting in the panel cut-out. Exception: For indicators type NIR3-060... and NIR3-080... 3 fastening screws.
- 8-pole plug connector

2.6 Accessories and spare parts

Available accessories

In addition to the installation material, the following accessories are available for Series NIR3..., NIQ3... indicators.

- Split ferrite Würth No. 742 711 31, Ø 6.0 ... 7.5 mm (necessary for type -I2 in conjunction with DIN EN 50155)
- Split ferrite Würth No. 742 711 32, Ø 7.0 ... 8.5 mm (necessary for type -I2 in conjunction with DIN EN 50155)

Available spare parts

Available spare parts include installation material and connectors. For detailed information please contact our Service department or marketing team at sales@noris-group.com.

2.7 Packaging and its disposal

Indicator packaging

The indicator is packed in a polyethylene bag in a cardboard box. The mounting screws are packed in a separate polyethylene bag. The polyethylene bag and the cardboard box protect the device from dirt, dust, moisture and prevent the housing from being scratched. To avoid damaging the device only unpack it directly before installation. If you remove the device as part of system maintenance, it should be kept in the polyethylene bag and in the cardboard box to avoid damage.

Disposal of packaging

If the packaging is no longer required, it should be disposed of in accordance with the locally applicable waste disposal regulations.

3 Product description

3.1 Scope of application

NORIMETER 3 indicators are mainly used in the Shipbuilding industry, transport technology and mechanical engineering. The indicators fulfill the requirements of the DIN EN 50155 for railway technology and of common ship classification societies and thus, are suitable for applications in harsh environments. Thanks to the mechanical construction, the housing is highly resistant against salt spray and thus, outdoor use is possible. The DIN-compliant housing sizes are suitable for installation in control cabinets and control panels with pre-stamped standardised installation openings.

3.2 Indication principle and measurement signal resolution

Indicator principle
Type NIQ3, NIR3

The display on the NORIMETER 3 is via a high-resolution stepper motor with integrated precision transmission at a resolution of 12 steps per degree. A display with a 240° standard scale thus achieves a resolution of the measuring signal in 2880 display steps. The motor itself has a mechanical transmission end stop and an angle of rotation of 315°. This makes a scale angle of up to 300° possible. In addition, a display with a 360° rotating faceplate is available (see data sheet DB-NIQ31).

The motor is controlled by the firmware via a digital filter. This results in an optimum combination of smooth adjustment of the measure value and high precision (without the pointer wavering). The transmission backlash is almost halved by the firmware. This measure allows a display accuracy greater than 0.5% to be achieved relative to the measuring range.

Indicator principle
Type NIQ31

A high resolution motor without a mechanical stop is used in 360° indicators to enable continuous rotation of the dial. The entire measuring range is divided into 4320 graduations. As the motor in this indicator has no mechanical stop, the zero point is found by scanning of a position marker on the underside of the dial.

Gear backlash of the stepper motor is virtually eliminated by a special motor controller. This method enables pinpoint positioning accuracy of the dial in both directions. The indicator additionally corrects the gear backlash every second when the dial is stationary. The reading is corrected if it deviates from the correct value (within the gear backlash) due to impact or vibration.

3.3 Indicator design

Indicator Type NIQ3...

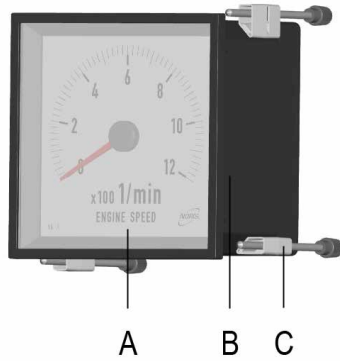

Indicator Type NIR3...

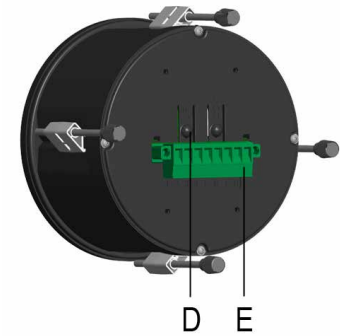
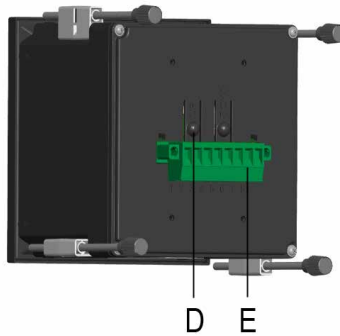
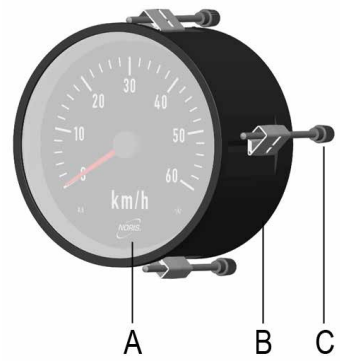

Legend to previous illustrations

- A) Non-reflective float glass
- B) Stable, glass-fibre reinforced plastic housing
- C) Mounting element
- D) 2x buttons (e.g. lighting control)
- E) 8-pin connector

3.4 Dial and pointer for Type NIQ3, NIR3

The markings and the graduation of the scale are in accordance with DIN43802 and DIN43780 but can also be customer-specific on request.

Scale and pointer – standard versions (in acc. with DIN 43802 and DIN 43780)		
	White scale dial	Black scale dial
Scaling and scale markings	Black	White
Type of graduation	Coarse-fine graduation	
Scale dial illumination	Scale dial illumination, white	White illumination of scaling and scale markings
Pointer versions	Black pointer, unlit	Illuminated pointer: white, red when lit

Scale – individual versions	
Scale and scale markings	Available in all RAL colours in accordance with customer requirements, own logos possible
Type of graduation	Orientation graduation or any other desired graduation of the scale available according to customer requirements
Scale illumination effects with black scales	Without illumination the scaling and scale markings are white, with illumination the scaling and scale markings are red, green or in another translucent colour

Pointer – individual versions		
Pointer unlighted	Black	
Illuminated pointer	Unlighted: white	Illuminated: White, red, yellow, other colours available on request
	Unlighted: Yellow	Illuminated: Yellow
	Unlighted: Red	Illuminated: Red
	Unlighted: Other colours available on request	Illuminated: Colour selected

3.5 Scale and dial for Type NIQ31

The scale is marked and graduated according to customer requirements.

Scale and dial (black)		
	Standard version	Customised versions
Graduations and dial markings	Left red, right green	Available in all RAL colours in accordance with customer requirements, own logos possible
Type of graduation	Orientation graduation or any other scale graduations available according to customer requirements	
Illumination	White	
Scale illumination and dial illumination effects	- - -	Without illumination: white graduations and scale markings; with illumination: graduations and scale markings red, green or in any other translucent colour
Dial	Black with white symbol (translucent)	Black with customised symbol in any colour (translucent)

Note:

The scale and dial are also possible in white or any other RAL colour but without illumination.

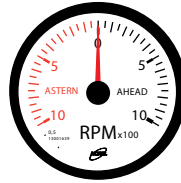
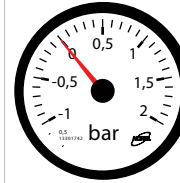

3.6 Zero point, return point and scale measuring range

For Type NIQ3, NIR3

Scale zero point	The position of the scale zero point can be specified as required.		
	Scale zero point on the right (Standard)	Scale zero point in the middle (Standard)	Scale zero point: customer-specific
			

<p>Return point</p>	<ul style="list-style-type: none"> When the power is off, the pointer turns to the return point. The position can be specified as required. The return point must not be the zero point (e.g. to allow power failures to be detected in the live zero function) 	
<p>Measuring range</p>	<ul style="list-style-type: none"> Note the difference between the printed measuring range on the scale (can be individually defined) and the signal measuring range (predefined, see type code) All common standard signals as well as customer-specific signal measuring ranges can be processed. Scale spread (see figure on the right) and non-linear measuring ranges are available on request. 	<p>Scale spread</p> 

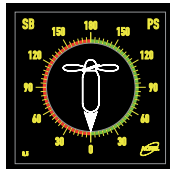
For Type NIQ31

<p>Possible versions</p>		
<p>Scale zero point</p>	<p>The position of the scale zero point can be specified as required.</p>	
	<p>Standard: Scale zero point in 12 o'clock position</p> 	<p>Option: Scale zero point in 6 o'clock position</p> 
	<p>Option: Scale zero point in any position</p> 	
<p>Start of signal with positioning optimisation (*)</p>	<ul style="list-style-type: none"> Standard: Start of signal at scale zero point Option: Start of signal in any other position, e.g. 8 o'clock position 	
<p>Without positioning optimisation (*)</p>	<ul style="list-style-type: none"> 360° indicators without positioning optimisation(*) (with dial return) are available as special types, e.g. for measuring temperature, pressure, frequency, etc. (scale angle ≤ 360°) 	

Possible versions	
Return point	<ul style="list-style-type: none"> ▪ The dial moves to the return point when operating voltage is no longer applied ▪ The return point does not need to be the scale zero point ▪ Standard: Return point at scale zero point ▪ Option: Return point in any other position
Measuring range	<ul style="list-style-type: none"> ▪ Standard: Indicator with linear measuring range, right side 0...175° (green), left side 180...5° (red) ▪ Option: Indicator with non-linear measuring range (scale spread)
Scale angle	<ul style="list-style-type: none"> ▪ Standard: 360° ▪ Option: Any scale angle < 360°

(*) Positioning optimisation

The dial in indicators with positioning optimisation can turn in a circle. The dial in indicators without positioning optimisation only turns between the minimum and maximum signal.

4 Technical data

Electrical connection	
Supply voltage	18 ... 36 VDC, other voltages on request
Nominal voltage	24 VDC
Power consumption	2 W maximum
Reverse voltage protection	Yes
Over voltage protection	Yes
Connection	8-pin connector
Galvanic isolation	4 galvanically isolated inputs and outputs
Input signal	
Analogue measurement signals	0...10 VDC (Ri = 29 kΩ); 2...10 VDC; (Ri = 29 kΩ); -10...+10 VDC (Ri = 26 kΩ); 0...20 mA DC (Ri = 121 Ω); 4 ... 20 mA (Ri = 121 Ω); -20 ... +20 mA (Ri = 59 Ω); customer-specific measuring ranges on request
Frequency signals	Frequency range: 0.2 Hz...140 kHz; full-scale value ≥ 10 Hz...140 kHz; < 0.2 Hz is shown as 0 Hz Signal shape: all signal shapes Alternating voltages: 200 mVpp ... 400 Vpp; Pulsating direct voltage: Low level ≤ 4 V; high level ≥ 6.5 V, max. 200 Vp Internal resistance Ri: > 220 kΩ for all signals, 10 kΩ termination available Sensor type options: Sensors with measuring amplifier and with "open collector" as NPN or PNP output or with push-pull output stage; inductive sensors without measuring amplifier; tachogenerators: with alternating voltage output Note: For "open collector" PNP or NPN sensors without internal pull-up or pull-down resistors, a corresponding 10 kΩ resistor can be switched in the NORIMETER 3 on request.
Resistive sensor signals	Pt100/Pt1000 in 2-, 3- and 4-wire technology; -30 °C ... 600 °C; measuring current Pt100 = 1.6 mA, Pt1000 = 0.17 mA NTC thermistor; H1: 40...120 °C; H2: 5...70 °C; H3: 114...200 °C Resistance, customer-specific compensation
Input for illumination control	Commercially available 24 V PWM dimmers (positive or negative regulator) or 0...24 V DC or AC voltage (either polarity); Ri = approx. 17 kΩ
Auxiliary input (binary input)	Binary connection, for external control of alarm LED or blinking pointer ; ≤5V = Off (Low); ≥9 V up to max. 36 V = On (High)

Input signal	
Auxiliary input (direction-of-rotation monitoring, multi-wire)	Pin 5: Q2 input for direction of rotation signal for frequency indicators with direction of rotation indication (input for wire 3 for PT100 / PT1000 in three-wire or 4-wire technology; Pin 6: input for wire 4 for PT100 / PT1000 in four-wire technology)
Auxiliary output (relay output)	Magnetic contact relay, switching contact as normally closed or normally open as operating or closed-circuit current Maximum switch voltage: 110 VDC or 125 VAC Maximum switch current: 1 A at ≤ 30 VDC; 0.5 A at ≤ 125 VAC (at resistive load) Maximum switch capacity: 30 WDC or 62.5 WAC (at resistive load) Maximum contact resistance: 50 m Ω
Class of accuracy	IEC 60051-1: 0.5
Measurement signal resolution	10 Bit
Stepper motor resolution	12 motor steps per angular degree

Environmental influences	
Operating temperature	Reference range of operation: -25 ... +70 °C, nominal range of operation: -25 ... +70 °C
Storage temperature	-40 ... +70 °C (max. peak values within 30 day/year at relative humidity of 5...95%)
Protection class	IEC 60529: Front of housing IP66, IP67 and IP68 (1 m, 24 h); rear of housing IP30 (standard, higher on request)
Salt spray resistance	IEC 60068-2-52: Test severity class 1 (open deck) and test severity class 4 (de-icing salt)
Vibration resistance	DIN IEC 60068-T2-6: 4 g, test duration 3 x 90 minutes (at 100 Hz)
Shock resistance	EN 61373 Cat. 2: 5 g at 30 ms; 10 g at 18 ms
Climatic test	IEC 60068-2-1: dry coldness -25 °C, test duration 16 h IEC 60068-2-2: dry heat 70 °C, test duration 16 h IEC 60068-2-30 damp heat $\leq 95\%$ relative at 55 °C, test duration 2 x 12 h
ESD	IEC 61000-4-2 and EN 50121-3-2, Tab. 9.3, evaluation criterion "A": Air discharge 8 kV; contact discharge 6 kV
Burst	IEC 61000-4-4 and EN 50121-3-2 table 7.2 and table 8.2: 2 kV for supply connection, signal connection, data connection and control connection
Surge	IEC 61000-4-5, EN 50121-3-2, Tab. 7.3: US+ to US- with 1.0 kV, $R_i = 2 \Omega$

Environmental influences	
RF interference immunity	IEC 61000-4-3: 80 MHz...2 GHz, 80% AM with 1 KHz, E = 10 Veff/m EN50121-3-2, Tab. 9.1 und 9.2: 80 MHz...1 GHz, 80% AM with 1 KHz, E = 20 Veff/m 1.4 GHz...2.1 GHz, 80% AM with 1 KHz, E = 10 Veff/m 2.1 GHz...2.5 GHz, 80% AM with 1 KHz, E = 5 Veff/m
Conducted RF interference	IEC61000-4-6 and EN50121-3-2, Tab. 7.1 and 8.1: f = 150 kHz ... 80 MHz at 80 % AM @ 1 kHz, V = 10 Veff
Conducted AF interference	GL2012 GL2003: 50 Hz...10 kHz, V = 3 Veff
Emitted interference	CISPR 16-1, CISPR 16-2 EMC2 EN50121-3-2, Tab. 4: Battery-related connections 150 KHz...30 MHz EN50121-3-2, Tab. 6: Housing 30 MHz...1 GHz
Insulation voltage	1000 VDC between all electrical inputs and outputs

Mechanical properties	
Housing material	Glas fibre reinforced, salt spray resistant and uv stabilised plastic; upper part: PC GF10; base plate: PC GF30; face made of lumenized float glass
Mounting	Fastening screws with dovetail key and hand knob (tool-less)
Installation position	Any
Weight	NIQ3-072: 170 g NIQ3-096: 250 g NIQ3-144: 510 g NIR3-060: 145 g NIR3-080: 185 g NIR3-100: 245 g NIR3-130: 375 g
Housing sizes	Square: 72x72 mm, 96x96 mm, 144x144 mm Round: Ø 60 mm, Ø 80 mm, Ø 100 mm, Ø 130 mm

Other	
Illumination	Externally dimmable LED illumination
Initialising time	Approx. 5 s after switching on the supply voltage
Minimum switch on period	2 minutes to permanently save a changed default brightness setting; 3 minutes so that the pointer returns to the zero point from any position
Scale angular	With pointer up to max. 300° (standard 240°)
Fire protection	DIN EN 45545; UL94: V0 (all housing parts)
Approvals	ABS, BV, DNV-GL, LR, MED, CE, UKCA
Further standards	DIN EN 50155 (railway application)

5 Installation

5.1 Information on avoiding faults and damage

NOTICE

Installation must be carried out exactly as described in this manual. If customer drawings with deviating information are available they have priority over the information in this manual.

Follow the information and instructions. The indicator may otherwise be damaged.

NOTICE

Make sure that the ambient conditions at the place of installation correspond to the requirements specified in the technical data.

Use in direct sunlight should be avoided due to possible temperature and other effects inside the housing.

5.2 Indicator installation

5.2.1 Control panel cut-out

A correspondingly sized cut-out in the control panel is required to install the indicator.

- A. Make the cut-out in the control panel for your indicator as specified in the next table.

NOTICE

Make sure that the cut-out in the control panel matches the dimensions specified for your indicator in the table below. Make sure that the cut-out has no sharp edges. Do not use force to fit the indicator in the cut-out.

Otherwise the indicator may be damaged while fitting in the cut-out.

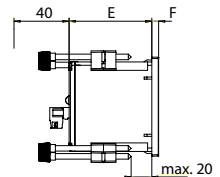
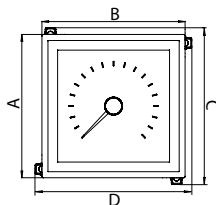

Indicator type	A	B	C	D	E	F	Panel cut-out	Permissible deviation
NIQ3-072...	72	72	81	81	60	5	67.5 x 67.5	+0.5
NIQ3-096...	96	96	105	105	60	5	91.5 x 91.5	+0.8
NIQ3-144...	144	144	153	153	61	8	137.5 x 137.5	+1.0

All values in this table in mm

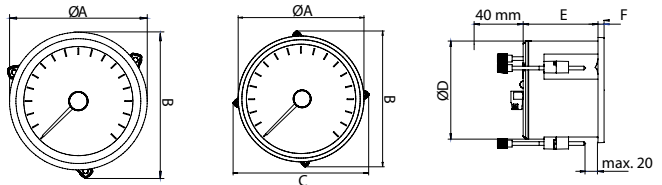

NIR3-060, NIR3-080

NIR3-100, NIR3-130

Indicator type	A	B	C	D	E	F	Panel cut-out	Permissible deviation
NIR3-060...	66	71.5	-	60	61	5	Ø 60.5	+0.5
NIR3-080...	86	91.5	-	80	61	5	Ø 80.5	+0.5
NIR3-100...	106	116.5	116.5	100	61	5	Ø 100.5	+0.5
NIR3-130...	136	146.5	146.5	130	63	6	Ø 130.5	+0.5

All values in this table in mm

5.2.2 Securing the indicator

Depending on the installed location and design of the control panel it may be advisable to make the electrical connections to the indicator first and then secure the indicator in the panel (see section Connection and cable installation).

- ▶ **Prerequisite:** You have placed the indicator in the corresponding cut-out in the control panel.
- A. Fit all mounting screws in the corresponding positions on the indicator (see next Fig.).
 - ⇒ There are 3 or 4 mounting screws depending on the design and size of the indicator. All supplied mounting screws must be used to ensure the indicator is fitted securely.

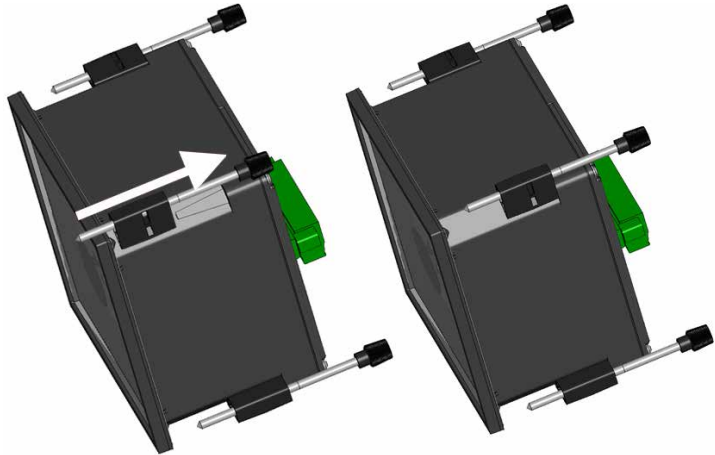

1: Indicator mounting elements

- B. Turn the knurled screws clockwise until they make contact with the inner side of the control panel. Now turn the knurled screws further by several turns until the indicator is secure.

NOTICE

Do not use force to screw in the knurled screws.

Otherwise the indicator housing or the mounting element may be damaged.

➔ The indicator is now securely installed.

NOTICE

Only two mounting elements may be needed in special cases, e.g. instruments arranged next to each other in a block without spacing.

In this case, the control panel cut-out must be sufficiently reinforced in order to maintain the protection class.

5.3 Connection and cable installation

NOTICE

Make sure that the indicator is connected correctly.

Incorrect wiring and incorrectly or inappropriately tightened connector mounting screws may result in signal loss or damage to the indicator or connection.

NOTICE

Make sure that the connection cables are installed correctly.

Incorrectly installed connection cables can result in signal loss or damage to the indicator.

Electrically connect your indicator as described in this section.

- A. Screw the connection cables to the connector. Refer to the corresponding connection diagram for your indicator in this section.
- B. Plug the connector into the socket of the indicator and secure the connector with the two screws.

Please note that, depending on the type of indicator, the auxiliary connection (Pin 5 and 6) is not used or is assigned as an input or output. This must be taken into account when connecting the indicator.

5.3.1 Measured variables

The following measured quantities with the specified signal measurement ranges can be connected directly to type NORIMETER 3 indicators without using additional measuring transducers. Other measured quantities are available on request with additional measuring transducers.

DC voltage

Indicator type	Measurement range
-U1	0...10 V
-U2	2...10 V
-U4	-10 V ...0... +10 V
-U0	<p>Special calibration: freely selectable within the specified range limits below.</p> <ul style="list-style-type: none"> ▪ Minimum range limit: 0...100 mV or -50 mV...0...+50 mV ▪ Maximum range limit: 0...300 V or -150 V ...0... +150 V <p>For further information please read the technical data.</p>

DC current

Indicator type	Measurement range
-I1	0 ... 20 mA
-I2	4 ... 20 mA
-I4	-20 mA ...0... +20 mA
-I0	<p>Special calibration: freely selectable within the specified range limits below.</p> <ul style="list-style-type: none"> ▪ Minimum range limit: 0 ... 20 µA or -10 µA ...0... +10 µA ▪ Maximum range limit: 0...500 mA or -250 mA ...0... +250 mA <p>For further information please read the technical data.</p>

Frequency

Indicator type	Measurement range
-F1	For square wave signals or other pulsating DC voltages, for AC voltages $\geq 20V_{pp}$, e. g. for sensors with measuring amplifier and tachogenerators
-F2	For AC voltages, e. g. for inductive sensors without measuring amplifier (Note: From an amplitude of $\geq 20V_{pp}$ or higher, the type „-F1“ should be used for AC voltages, too)
-FD1	For square wave signals or other pulsating DC voltages with second measuring channel for direction of rotation detection, e. g. for sensors with measuring amplifier, but not suitable for tachogenerators
-FD2	For AC voltages with second measuring channel for direction of rotation detection, e. g. for inductive sensors without measuring amplifier and tachogenerators
<p>Measurement range: 0.2 Hz to 140 kHz; Scale end value: ≥ 10 Hz to 140 kHz; frequencies under 0.2 Hz will be show as 0 Hz</p> <p>Signal form: all signal forms</p> <p>Signal level: Type -F1 or -FD1 (pulsating DC voltage and AC voltages $\geq 20 V_{pp}$): Low level $\leq 4 V$, High level $\geq 6,5 V$. Type -F2 or -FD2 (AC voltage): $200 mV_{pp}$ to $400 V_{pp}$. Other signal levels available on request. Please also note the information in the technical data!</p>	

Temperature Pt100/Pt1000

Indicator type	Type	Signal measurement range
-Px / -PTx	Pt100 / Pt1000 with two-wire-connection	x=1 [0 ... 120 °C] x=12 [0 ... 100 °C] x=11 [-30...120 °C]
PxL3 / PTxL3	Pt100 / Pt1000 with three-wire-connection	x=2 [0 ... 150 °C] x=3 [0 ... 200 °C] x=4 [0 ... 250 °C] x=5 [0 ... 300 °C] x=6 [0 ... 400 °C]
PxL4 / PTxL4	Pt100 / Pt1000 with four-wire-connection	x=7 [0 ... 500 °C] x=8 [0 ... 600 °C] x=0 [Special calibration freely selectable within the specified range limits]: Start limit: -30 °C ... 0 °C End limit: 50 °C ... 600 °C Example: PT0, measurement range: -10 °C... 220 °C or -5 °C ... 180 °C

Temperature NTC Thermistor

Indicator type	Signal measurement range
-H1	40 ... 120 °C
-H2	5 ... 70 °C
-H3	114 ... 200 °C
-H0	Special calibration: Other signal measurement ranges available on request

Resistance

Indicator type	Signal measurement range
-R0	Indicators with resistance measuring input are suitable for resistive sensors (e. g. pressure sensors, level meter, etc.) in two-wire connection. The signal measurement range is freely selectable between 0...10 Ω and 0...500 Ω.

5.3.2 General connection assignments and connector variants



2: N1x3 connector

Pin	Indicator labeling	Description
1	$U_s +$	Supply voltage +
2	$U_s - (0V)$	Supply voltage - (0V)
3	Illum. + (<24V)	Illumination control input, positive (24 VDC)
4	Illum. -	Illumination control input, negative
5	Signal LED / N.C. / Q2 (type-specific)	Auxiliary positive connection
6	24 VDC / N.C. (type-specific)	Auxiliary negative connection
7	Meas. Sign. + (type-specific)	Measuring signal input, positive
8	Meas. Sign. - (type-specific)	Measuring signal input, negative

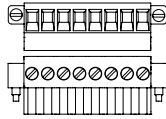

Connector with straight cable outlet (standard)

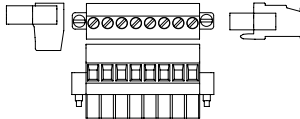

Connector with 90° angled cable outlet (optional)

5.3.3 Connection diagrams of the various indicator types

Two types of connector are available corresponding to the order.

Free pins in the diagrams below are not connected for the respective signal type.

Type -F1

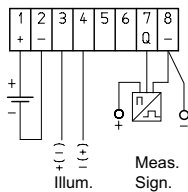

Type -F2

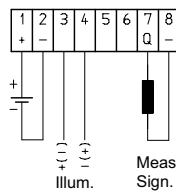

Type -FD1

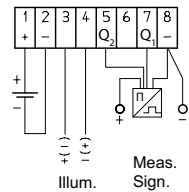

Type -FD2

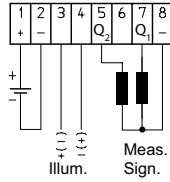

**Type -I1, -I2, -I0
Type -U1, -U2, -U0**

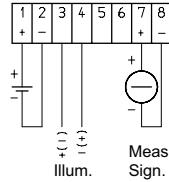

Type -I4, -U4, -UG0,

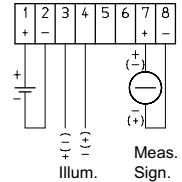

**Type -H1, -H2, -H3,
-R0 see * in Fig.**

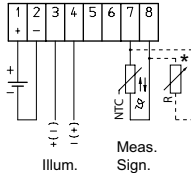

Type -Px, -PTx (2-wire)

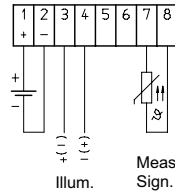

**Type PxL3, Type
PTxL3 (3-wire)**

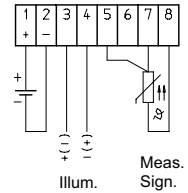

**Type -PxL4, -PTxL4 (4-
wire)**

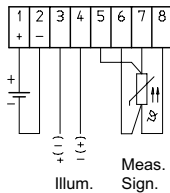

**Connection of relay
output
or 24 VDC control in-
put**

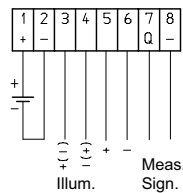

**Connection of
Auxiliary push button**

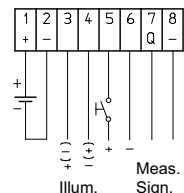

Indicator with auxiliary connection as input (e.g. Reset button)

The auxiliary connection on these devices is assigned as an input for a Reset button, e.g. to reset a status LED. In this case, a 24 VDC voltage is fed via a button to Pin 5 and 6.

Indicator with auxiliary connection as limit value switch output

The auxiliary connection on these devices is assigned as a relay output. An external device (e.g. horn or signalling device) is switched when a defined limit is reached.

Note on using Type -I2 together with DIN EN 50155

A Snap-on Ferrite must be fitted on the connection cable directly at the connector for Type -I2 indicators in connection with DIN EN 50155 for railway applications. The following types are recommended:

1. Snap-on Ferrite Würth No. 742 711 131, Ø 6.0 ... 7.5 mm
2. Snap-on Ferrite Würth No. 742 711 132, Ø 7.0 ... 8.5 mm

6 Commissioning

6.1 Tools and equipment



Have the following tools and equipment ready for commissioning:

- Multimeter (for indicator with current/voltage input)
- 2-channel oscilloscope (for frequency indicator)
- Pt100/Pt1000 simulator (for temperature indicator)
- Controlled laboratory power supply unit

NOTICE

Make sure that the tools and equipment are in perfect working order.

Otherwise the results of the measurements described below may be falsified.

6.2 Checking operating voltage and illumination control

Check that the operating voltage U_{NOM} and the voltage for the illumination comply with specifications:

NOTICE

The electronics of the indicator may be damaged if the operating voltage or the voltage for illumination control exceeds the maximum permissible value.

Therefore, check the operating voltage and the voltage for the illumination control prior to start-up.

- ▶ **Prerequisite:** The connector has been wired correctly. The connector is not plugged into the indicator.
 - ▶ **Prerequisite:** The operating voltage is applied.
 - ▶ **Prerequisite:** The voltage for the illumination is applied.
 - ▶ **Prerequisite:** The illumination control is set to maximum.
- A. Set the measuring range for DC voltage.
 - B. Connect the multimeter [+] to $U_B +$ [Pin 1] and multimeter [-] to $U_B -$ (0V) [Pin 2].
 - ➔ **Result:** The multimeter shows U_{NOM} or is within the specified range (see "Technical data [▶ 16]").
 - A. Connect the multimeter [+] to illumination control input Positive [Pin 3] and multimeter [-] to illumination control input Negative [Pin 4].
 - ➔ **Result:** The multimeter shows ≤ 24 VDC.

6.3 Checking the input signal

Check the input signal before using the indicator.

NOTICE

The polarity of the signal inputs for Type -I1, -I2, -I0, -U1, -U2 and -U0 must not be reversed.

The indicator may otherwise be damaged.

NOTICE

Make sure the input signal complies with the specifications for your indicator.

The indicator may otherwise be damaged.

6.4 Referencing

After the operating voltage is applied, the indicator performs a referencing run to establish the zero point positioning.

6.5 Indicator-specific settings

6.5.1 Factory settings

Remember

All previously stored settings are irreversibly lost when the indicator is reset to the factory default.

Functional description

The changes made on all setting levels can be reset to the factory settings as required with the buttons as the rear of the device.

Function call

How to reset the indicator to the factory settings

- A. Simultaneously press and hold both buttons directly after switching on the device (operating voltage connection) and before referencing has finished until the light flickers.
 - ➔ The indicator is reset to the factory settings.

6.5.2 Illumination control

Illumination control for indicator Type NIQ3 and NIR3

Functional description
Type NIQ3, NIR3

Scale and illuminated pointer (if integrated) are lit via two separate, controllable systems on an LED basis. The scale is brightly and uniformly lit from the rear via a light panel (transmitted light principle). The power dissipation and thus the intrinsic heat build-up of the indicator is very low. The illuminance can be set between 0 and 100% in 1% steps. The default setting for both illumination systems is 100%.

Three ways to control the brightness:

Setting the default brightness	<ul style="list-style-type: none"> ▪ Setting between 30% and 100% using the two buttons (up/down) on the rear of the indicator housing (allows it to be adapted it to suit the default brightness setting of other equipment in the surrounding area) ▪ This setting influences both the scale and the pointer illumination. ▪ The change in brightness is saved in the internal flash memory (even after switching off the supply voltage).
Illumination control via a control signal on the connector	<ul style="list-style-type: none"> ▪ Control of the illumination between zero and the preset default brightness ▪ This setting influences both the scale and the pointer illumination. ▪ Controllable via commercially available 24V dimmer or a DC or AC voltage with any polarity (0...24 V)
Separate adjustment of the illuminated pointer (if installed)	<ul style="list-style-type: none"> ▪ Setting between 30% and 100% using the two buttons (up/down) on the rear (in second button level) ▪ Change of brightness is saved in the flash memory.

Illumination control for 360° indicator Type NIQ31

Functional description
Type NIQ31

A common, controlled LED illumination system illuminates the scale and dial. The scale and dial are lit brightly and uniformly from the rear by a light panel (transmitted illumination principle). The power dissipation and thus the intrinsic heat build-up of the indicator are very low. The illuminance can be set between 0 and 100% in 1% steps.

Two ways to control the brightness:

<p>Setting the default brightness</p>	<ul style="list-style-type: none"> ▪ Setting between 30% and 100% using the two buttons (up/down) on the rear of the indicator housing (allows it to be adapted to suit the default brightness setting of other equipment in the surrounding area) ▪ The factory default for illumination brightness is 100 %. ▪ This setting influences both the scale and dial illumination. ▪ The change in brightness is saved in the internal flash memory (even after switching off the supply voltage).
<p>Illumination control via a control signal on the connector</p>	<ul style="list-style-type: none"> ▪ Control of the illumination between zero and the preset default brightness ▪ Controllable via commercially available 24V dimmer or a DC or AC voltage with any polarity (0...24 V)

6.5.2.1 Setting the basic brightness

Functional description

The background illumination of the indicator and the pointer illumination level (for devices with illuminated pointer) can be adapted to the illumination of the instrument in the vicinity with the two buttons at the rear of the device.

Function call

How to set the brightness of the indicator illumination

- ▶ **Prerequisite:** Setting level 0 is active (this level is always active after switching on the device and when no other level was activated).
- A. Set the required brightness level with the two buttons <<UP>> (brighter) and <<DOWN>> (darker) at the rear of the device.
 - ⇒ The illumination will briefly flicker when the upper or lower setting limit is reached.
- ➔ The setting is saved automatically. The minimum ON period must be observed (see Technical Data under "Miscellaneous").

Function call

How to set the brightness of the illuminated pointer

- ▶ **Prerequisite:** The indicator has an illuminated pointer.
- ▶ **Prerequisite:** Setting level 1 is active.
- A. Set the required brightness level with the two buttons <<UP>> (brighter) and <<DOWN>> (darker) at the rear of the device.
 - ⇒ The illumination will briefly flicker when the upper or lower setting limit is reached.
- ➔ After none of the buttons is pressed for 10 seconds, setting level 0 is active and the indicator light briefly flickers. The set value is now permanently stored.

6.5.2.2 External illumination control

In addition to the basic brightness setting, the illumination can also be controlled by an external control signal at the connection terminal (Pin 3 and Pin 4, see "Nix3 connector [▶ 25]"). Commercially available 24 V PWM dimmers (positive or negative regulator) or 0...24 V DC or AC voltage (any polarity) can be used for this purpose. The illumination can be controlled between 0 and the set basic brightness (see Section "Setting the basic brightness [▶ 31]").

6.5.3 Linear line compensation for temperature indicator

Functional description

The display can be changed by up to $\pm 5\%$ of the full-scale value with linear line compensation. The line resistance of resistive sensors (PT100/PT1000, NTC thermistors, etc.) is compensated in this way. It is recommended to use a PT100/PT1000 simulation unit for line compensation. The factory default can be reset (see Section "Factory settings [▶ 29]").

NOTICE

ATTENTION: Line compensation changes the factory setting. Incorrect line compensation can cause the reading to deviate from the actual measured values.

It may then not be possible to detect when limit values are overshoot or undershot. NORIS shall accept no liability for any damage which may be incurred as the result of incorrect line compensation.

Function call

How to carry out line compensation

- ▶ **Prerequisite:** Setting level 3 is active in order to perform linear line compensation.
- A. Now perform the compensation procedure with the <<UP>> and <<DOWN>> buttons at the rear of the device.
 - ⇒ The illumination will briefly flicker when the upper or lower setting limit is reached.
- ➡ After none of the buttons is pressed for 10 seconds, setting level 0 is active and the indicator illumination briefly flickers. The set value is now permanently stored.

6.5.4 Proportional line compensation

Functional description

With proportional line compensation, the value shown on the display can be changed by $\pm 10\%$. This makes it possible to compensate the voltage drop at the on the supply lines and at the connection terminals when measuring voltages. It is recommended to use a controlled laboratory power supply unit for line compensation. The factory default can be reset (see Section "Factory settings [▶ 29]").

NOTICE

ATTENTION: Line compensation changes the factory setting. Incorrect line compensation can cause the reading to deviate from the actual measured values.

It may then not be possible to detect when limit values are overshoot or undershot. NORIS shall accept no liability for any damage which may be incurred as the result of incorrect line compensation.

Function call

How to carry out line compensation

- ▶ **Prerequisite:** Setting level 2 is active in order to perform proportional line compensation.
- A. Now perform the compensation procedure with the <<UP>> and <<DOWN>> buttons at the rear of the device.
 - ⇒ The illumination will briefly flicker when the upper or lower setting limit is reached.
- ➔ After none of the buttons is pressed for 10 seconds, setting level 0 is active and the indicator illumination briefly flickers. The set value is now permanently stored.

6.5.5 Setting direction of rotation for indicators with frequency input and direction of rotation recognition

Functional description

On indicators with a frequency input and integrated direction of rotation detection, the indicated direction of rotation for the input signal can be changed with the buttons at the rear of the device. This is practical, for example, for installation on various control panel (e.g. bridge or aft bridge).

Remember

The specified accuracy of 0.5% can only be guaranteed with the original factory setting.

Function call

- ▶ **Prerequisite:** Setting level 2 is active.
 - A. Change the direction of rotation of the pointer with the <<UP>> (clockwise) and <<DOWN>> (anticlockwise) buttons.
 - ➔ After none of the buttons is pressed for 10 seconds, setting level 0 is active and the indicator illumination briefly flickers. The set value is now permanently stored.
- Note:** The direction of rotation can also be changed by switching the two input signals Q1 and Q2.

6.5.6 Setting direction of rotation of motor for 360° indicators

Functional description

The direction of rotation of the motor can be set on Type NIQ31 360° indicators. This is practical, for example, when the direction of rotation of the indicator cannot be specifically determined with the built-in angle of rotation sensor.

Remember

The specified accuracy of 0.5% can only be guaranteed with the original factory setting.

Functional call

- ▶ **Prerequisite:** Setting level 1 is active.
- A. Change the direction of rotation of the motor with the <<UP>> (clockwise) and <<DOWN>> (anticlockwise) buttons.
 - ➡ After none of the buttons is pressed for 10 seconds, setting level 0 is active and the indicator illumination briefly flickers. The set value is now permanently stored.

6.5.7 Zero point calibration for 360° indicators

Functional description

The zero point of Type NIQ31 360° indicators can be calibrated with the buttons at the rear of the device. This is practical, for example, when the zero point of the rotary position sensor was not coordinated with the position of the engine nacelle during installation. A new zero point can be set in the preset direction of rotation only within the min/max limits of the old zero point. If an attempt is made to set the dial beyond the old zero point against the direction of rotation, the dial will stop at the old zero point and the indicator signal sensor error (slow illumination flashing). In this case, the new zero point must be set in the other direction of rotation.

Functional call

- ▶ **Prerequisite:** Mechanically, the engine nacelle is set to the zero point.
- ▶ **Prerequisite:** Setting level 2 is active.
- A. Change the zero point with the <<UP>> (forward direction of rotation) and <<DOWN>> (backward direction of rotation) buttons.
 - ➡ After none of the buttons is pressed for 10 seconds, setting level 0 is active and the indicator illumination briefly flickers. The set value is now permanently stored.

7 Operation

7.1 Min/max display

Functional description

Indicators with this optional auxiliary function register fluctuations of the measuring signal and save the highest and the lowest measured value in the internal measured-value memory. Critical measured values that, for example, occur during the absence of monitoring personnel can therefore be recalled later on. By means of a signal at the indicator's auxiliary port (e.g. via an external button), the saved values can be displayed or deleted.

Note: The min/max data is not permanently saved and is lost when the indicator is switched off.

Function call

- ▶ **Prerequisite:** The min/max display function is implemented in your indicator.
 - ▶ **Prerequisite:** You have connected a button to the auxiliary connection (see Section "Connection diagrams of the various indicator types [► 25]").
- A. Briefly press the button once to show the stored minimum value.
 - ⇒ The illumination flickers while the display is on.
 - ⇒ Normal display mode is activated again if a button is not pressed for at least 5 seconds.
 - B. Briefly press the button twice in succession to show the stored maximum value.
 - ⇒ The illumination flickers while the display is on.
 - C. To delete the stored values, press the button for at least 5 seconds until the indicator illumination stops flickering.
- ➡ The indicator illumination will stop flickering and normal display mode is activated when the min/max display function is active and a button is not pressed for at least 5 seconds.

7.2 Signalling LED and flashing pointer

Note: The functional principle required and the application (coupling) must be stated in the order and can then no longer be changed by the customer.

Information on signal LED:

- Red signal LED
- Positioned 2 cm below the pointer spindle
- Available as continuous light or with flashing frequency (2 Hz)
- Auxiliary "flashing pointer" function only available for indicators with illuminated pointers

The application can be selected as follows:

- Coupling to defined measured value, e.g. excessive speed or overtemperature, etc.
- Coupling to one or several measuring ranges, e.g. signal in the red measuring range or message out of the green measuring range. i.a.
- Coupling to measured value or measuring range with message memory:
 - Upon reaching the reporting range and subsequently leaving it, the signal LED remains lit.
 - The display is reset by a signal to the indicator's auxiliary port (e.g. external reset button)
- External control through a signal to the indicator's auxiliary input
- External control with concurrent coupling to a measured value or measuring range

7.3 Limit value switch output

Note: The functional principle of the relay contact and the subsequent assignment of the switching point must be stated in the order and can then no longer be changed by the customer.

Indicators with this auxiliary function have an additional relay card with switching output, with which an external device (e.g. a signal beeper or signalling device, etc.) can be switched.

The switching point of the limit value switch can be selected as follows:

- Coupling of the switching point to a defined measured value, e.g. excessive speed or overtemperature, etc.
- Change to the switching status in one or several measuring ranges, e.g. signal in the red measuring range or signal out of the green measuring range

For further information refer to the specifications for the relay contact in the technical data.

8 Maintenance

Indicators contain no wearing parts and are therefore classified as "maintenance-free devices" by the manufacturer. As part of system maintenance it is recommended to check the indicator mounting at regular intervals and, if necessary, to retighten the mounting screws to maintain the protection class.

9 De-installation and disposal

De-installation of indicators

NOTICE

If the indicator is removed, first disconnect the plug and then remove the fixing arrangements. After de-installation ensure that no parts remain in the panel.

The indicator or other devices in the panel may otherwise be damaged.

Disposal of defective indicators

Electric devices should not be disposed of together with normal waste. Dispose of the indicators in accordance with local requirements for electronic equipment.

10 Troubleshooting

Fault	Cause	Problem resolution
Slow flashing of dial and pointer at maximum brightness	Reading outside valid range; invalid signal	"Check signal [▶ 29]"
	Broken wire in the sensor cable	Repair cable
	Short circuit in the sensor cable	Rectify short circuit
	Sensor defective	Check sensor, replacing if necessary
Lighting too dark / no lighting	DC voltage at external lighting control input too low	Check DC voltage at external lighting control input
	Basic brightness level too low	"Adjust basic brightness level [▶ 31]"
	Wire break	Repair cable

11 Service

Do you have any questions or do you require help with the installation, commissioning or maintenance? Contact our Service representatives:

NORIS Automation GmbH

Muggenhofer Str. 95
90429 Nuremberg
Germany
Phone: +49 911 3201 0
Fax: +49 911 3201 150
Email: info@noris-group.com
Web: www.noris-group.com

NORIS Automation GmbH

Friedrich Barnewitz-Str. 10
18119 Rostock
Germany
Phone: + 49 381 519944-0
Fax: + 49 381 519944-4
Email: info@noris-automation.de
Web: www.noris-group.com

NORIS Benelux B.V.

Nieuwland Parc 10L
2952DA Alblasterdam
Netherlands
Phone: + 31 78 890 7550
Fax: + 31 84 870 7666
Email: service.nblx@noris-group.com
Web: www.noris-group.com

NORIS Automation Far East Pte. Ltd.

No. 42 Toh Guan Road East
#01-80 Enterprise Hub
Singapore 608583
Singapore
Phone: + 65 62 67 85 36
Fax: + 65 62 67 85 37
Email: singapore@norisautomation.com

NORIS-SIBO Automation Co. Ltd.

G/F, No. 8 Building South
No. 2716 Pingliang Road, Yangpu
Shanghai (200090)
Phone: +86 21-68761180
Fax +86 21-68758808
Email: info@noris-sibo.com