

Limit-value switch for frequency NORIS standard signal input



RF5..

Limit-value switches

- Straightforward application
- Suitable for severe operating conditions
- Compact construction
- Limit value freely adjustable by drum scale
- Anti-tamper seal for drum scale
- Frequency ranges to suit customer requirements
- Provision made for fine adjustment of measuring range
- Meet high EMC-requirements
CE requirements
- Volt-free output as normally closed contact or normally open contact
- Open-circuit or closed-circuit variants available
- Open-circuit devices with integrated push button to simulate an increased sensor signal for test functions without critical machine loading
- Optionally with latching function (only open circuit devices)
- Operating characteristics displayed by integrated LEDs
- Flame-inhibiting and self-extinguishing body
- Suitable speed sensors are available (NORIS devices FA../ FT..)

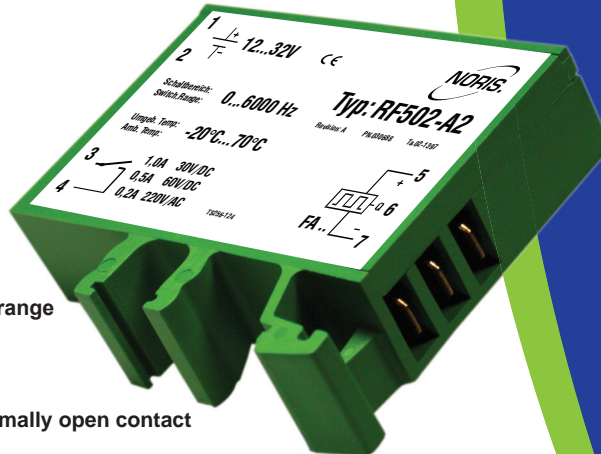

Image
RF502-A2



Germanischer Lloyd

Limit-value switches of series 5

Limit value switches of the series 5 are designed to monitor and process electric measured variables.

Working principle: When the actual value of the measuring signal supplied reaches the setpoint, the built-in relay will operate. The switching status of the relay contact may, for instance, be monitored or individually processed by a machine controller.

General notes on Type RF5..

Description RF5..

- Designed to monitor a NORIS standard frequency signal
- Suitable to evaluate outputs of sensors of the FT.. and FA.. series
- Factory-set maximum range frequency adjustment between 50 Hz and 10 kHz (maximum range frequency corresponds to 100 % of drum scale)
- Trimming potentiometer for re-adjustment of measuring range
- Limit value setpoint adjustable by means of drum scale from 5 ... 100 %
- Lowest limit value: 50 Hz (RF500..), 100 Hz (RF501..), 1,000 Hz (RF502..)

To avoid triggering errors the frequency full range set in factory must be the highest frequency of the measuring chain, the set point will be done in a ratio to the full range.

Test function for open circuit devices

Open-circuit devices have an integrated test button for testing purposes. As long as this button is kept pressed, the preselected limit value is decreased by abt. 15%. This enables safety functions, such as an overspeed trip to be tested without running the machine in the critical range.

Volt-free relay contact, closed-circuit or open-circuit version

A volt-free relay contact is provided as a normally closed or normally open contact for outputting and further processing. In addition, there is a choice between closed-circuit and open-circuit devices.

In the case of closed-circuit devices, the output relay is pulled up in the normal state of operation with the supply voltage applied. It drops off upon the limit-value being exceeded or if the supply voltage fails.

In the open-circuit variant, the output relay pulls up when the limit-value is exceeded with the supply voltage applied. Failure of the voltage will not result in any switching function below the limit value.

Latching function for open circuit devices

Open circuit devices can optionally be equipped with a latching function (see type code). When the limit value is exceeded, the relay keeps activated even if the signal falls below the limit value afterwards. The device has to be reset by disconnecting the supply voltage.

The NORIS standard signal

The NORIS standard signal corresponds to a rectangular voltage with an amplitude that corresponds to the supply voltage applied. This results in a signal that is immune to interference and tolerates considerable changes in the supply voltage. The supply voltage required by the sensor is provided by the limit-value switch.

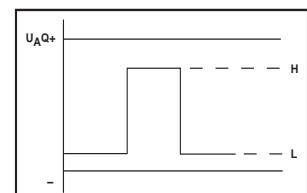

Technical Data

Series RF5..	
Supply voltage	$U_s=9 \dots 32$ V/DC, $U_R=24$ V/DC
Ripple	$< 20\%$ U_s
Reverse voltage protection	Integrated
Overvoltage	2.5 times U_R up to 2 ms
Voltage drops	100% up to 10 ms
Power consumption	Approx. 50 mA (24 V/DC)
Galvanic isolation	Between input signal and supply voltage
Input signal	NORIS standard signal from speed sensors FT.. / FA..
Input overloading	$< U_R$
Input resistance	Approx. 5,6 k Ω
Input current	< 5 mA
Output contact	Volt-free NOC or NCC, closed circuit or open circuit
Maximal switching capacity	30 W (1 A at 30 V/DC; 0.5 A at 60 V/DC) 40 W (0.2 A at 220 V/AC)
Limit value	Adjustable on tamper-proof drum scale between 5 ... 100%
Reproducibility	$< \pm 0.2\%$
Linearity of scale	$< \pm 1.5\%$
Hysteresis	Approx. 2% (1,5% for RF502-devices)
Test button function	Limit value lowered by approx. 15% (only open-circuit devices)
Error class	IEC51-1 1.5%
Temperature sensitivity	$< \pm 0.1\%$ per 10 °K
Voltage sensitivity	$< \pm 0.1\%$ for 10% change in supply voltage
Reaction time	$f=50$ Hz / 0,25 s, $f=100$ Hz / 0,2 s, $f=1$ kHz / 0,1 s, $f=10$ kHz / 50 ms
Vibration resistance	IEC60068-T2-6 15g increased strain, characteristic 2 (10 ... 100 Hz)
Shock resistance (impact)	DIN IEC60068-T2-27 300 m/s ² with 18 ms dwell time
Climatic test	IEC60068-T2-30
Operating temperature	-20 °C ... +70 °C
Storage temperature	-45 °C ... +85 °C
Humidity	RH 96% maximum
ESD	IEC61000-4-2 +/- 8 kV
Electromagnetic field	IEC61000-4-3 10 V/m $f=10$ kHz ... 2000 MHz, 80% AM @ 1 kHz 10 V/m $f=900$ +/- 5 MHz, 50% AM @ 200 Hz 10 V/m $f=1800$ MHz +/- 5 MHz, 50% AM @ 200 Hz
Burst	IEC61000-4-4 +/- 2 kV supply +/- 1 kV sensor
Surge	IEC61000-4-5 sym. +/- 1 kV ($R_s=2 \Omega$) asym. +/- 2 kV ($R_s=2 \Omega$)
HF-susceptibility	IEC61000-4-6 3 V _{pp} 80% AM @ 1 kHz $f=0.01 \dots 100$ MHz
LF-susceptibility	IEC60553 3 V _{pp} 0.05 ... 10 kHz
Interference field intensity	Basis CISPR 16-1, 16-2 reduced characteristic
Connection	DIN46244 flat connector, gold-plated A6.3 x 0.8
Protection class	DIN EN60529 Body IP20, terminals IP00
Mounting	Snap-fit on top-hat channel or G-channel
Installed position	Any
Body material	Thermoplastic polyester, green, fire protection class V0
Weight	55 g
Applied standards	CE requirements complied with, DIN EN 61000-6-2, DIN EN 61000-6-4, DIN EN 50155, approved by GL, BV, LR, DNV

Type key / variants

Device codes

R	Limit-value switch
F	Input signal
F	Frequency input for NORIS standard signal (sensor series FT / FA)
5	Type series
5	Type 5
00	Input range f_b / upper-range frequency f_e / limit value f_s
01	$f_b: 10 \dots 100$ Hz, $f_e: 50 \dots 100$ Hz, $f_s: 50 \dots 100$ Hz ($f_s \leq f_e$)
02	$f_b: 20 \dots 1,000$ Hz, $f_e: 100 \dots 1,000$ Hz, $f_s: 100 \dots 1,000$ Hz ($f_s \leq f_e$)
02	$f_b: 200 \dots 10,000$ Hz, $f_e: 1,000 \dots 10,000$ Hz, $f_s: 1,000 \dots 10,000$ Hz ($f_s \leq f_e$)
R1	Output contact as NCC in closed current
R2	Output contact as NOC in closed current
A1	Output contact as NCC in open-circuit current
A2	Output contact as NOC in open-circuit current
S1	Output contact as NCC in open-circuit current with latching function
S2	Output contact as NOC in open-circuit current with latching function

R F 5 01 -A2 (RF501-A2) order example

Other Data

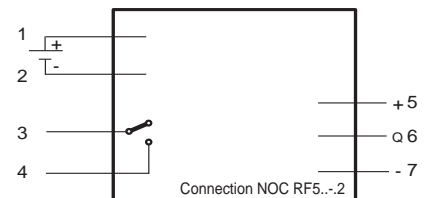
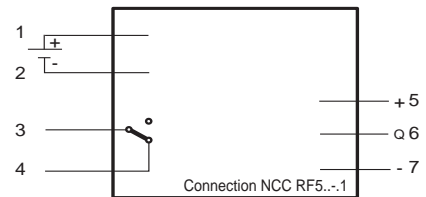
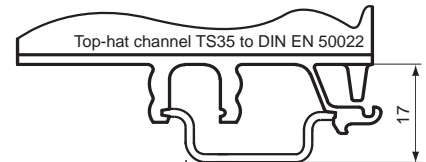
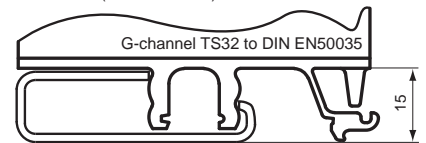
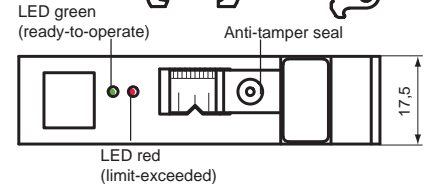
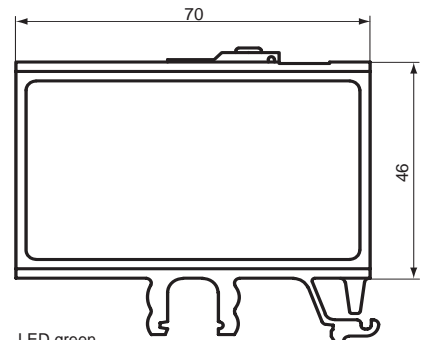

Relay position

	RF5...R1	RF5...R2	RF5...A1	RF5...A2	RF5...S1	RF5...S2
f < limit value	-	x	x	-	x	-
f > limit value	x	-	-	x	- (*)	x (**)

x = contact closed
- = contact open

(*) = Latching function: as -A1, but relay keeps open until U_s is disconnected
(**) = Latching function: as -A2, but relay keeps closed until U_s is disconnected
The red LED is illuminated, if the limit value is exceeded



NORIS Automation GmbH
Muggenhofer Strasse 95
90429 Nuremberg
Germany

Tel.: +49 911 3201-220
Fax: +49 911 3201-150
sales@noris-group.com
www.noris-group.com